





-  Vermentino col.01 liscio
-  Vermentino col.01 trapuntato
-  Ornellaia rosso col.10
-  Ornellaia marrone col.622



Jolly per composizione letto spessore 120mm

Con pannello togliere lo spessore della tavola alla gommapiuma

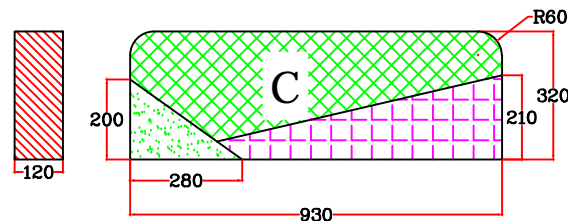
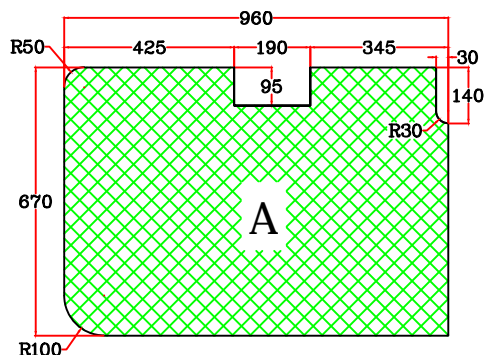
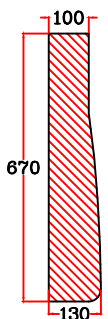
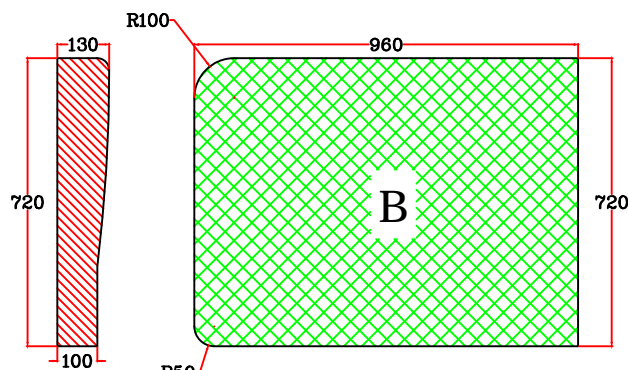
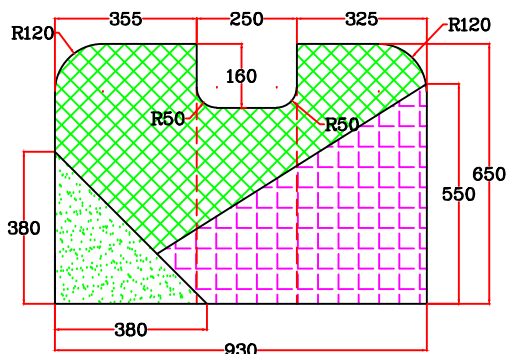
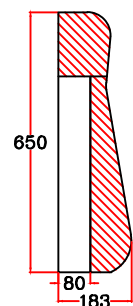
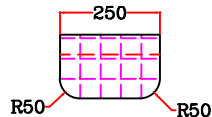
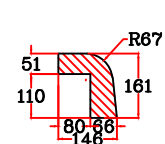
Con pannello togliere lo spessore della tavola alla gommapiuma

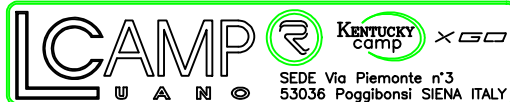
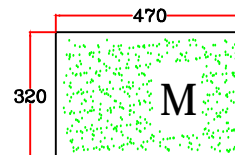
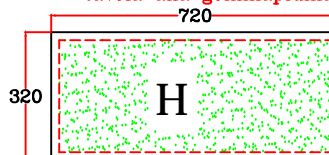
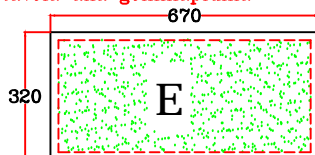
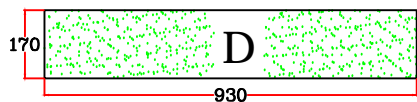

TOLLERANZE DI MASSIMA
Grado di precisione medio
UNI 5307

SEDE Via Piemonte n°3
53036 Poggibonsi SIENA ITALY

PAG 1 di 1
Data 05-02-2018
Data 05-02-2018

Denominazione

Cuscini Seal 3 - 5 - 7 - 12

Caratteristiche SCHIENALI-POGGIATESTA Densita'21 Kg/m³

gommapiuma SEDUTE-MATERASSI Densita'25 Kg/m³

Produzione 2018-2019

Meccanica RENAULT

NOTE Le dimensioni sono riferite al cuscino finito

Codice

1TAP090547

Codice lavorazione

Rev 00

Data 05-02-2018

Disegnato A.PINZUTI
Approvato A.PINZUTI

Rev

MODIFICA

DATA

ESEGUITA

I dati e le informazioni contenuti o ricavabili da questo disegno sono di esclusiva proprieta' della Luano Camp S.r.l. Ogni riproduzione totale o parziale e' vietata senza l'autorizzazione scritta della ditta Luano Camp S.r.l.



A4